



LG

Life's Good

ENGLISH

ITALIANO

ESPAÑOL

FRANÇAIS

DEUTSCH

EMHNIKA

ČEŠTINA

NEDERLANDS

POLSKI

LIMBA ROMÂNĂ

INSTALLATION MANUAL AIR CONDITIONER

- Please read this installation manual completely before installing the product.
- Installation work must be performed in accordance with the national wiring standards by authorized personnel only.
- Please retain this installation manual for future reference after reading it thoroughly.

TYPE : Refrigerant Leak Detector

MODEL : PLD-RNVOS



P/NO : MFL68102202

www.lg.com

TABLE OF CONTENTS

1. Safety Precautions	3
2. Components	5
3. Part Functions	6
4. Part Specification	7
5. Refrigerant Leak Detector	8
Main Features	8
Detector Alarm	9
6. How to Install	10
7. Installation Order	11
8. Test Run	14
Pre-check	14
Checking the refrigerant leak detector setting - Wired Remote Control	14
Checking the refrigerant leak detector setting - Wireless Remote Control	15
Leak Check for Refrigerant Leak Detector	16
9. Checkup before Reporting Trouble	18

1. Safety Precautions



To prevent injury to the user or other people and property damage, the following instructions must be followed.

- Be sure to read before installing the unit.
- Be sure to observe the cautions specified here as they include important items related to safety.
- Incorrect operation due to ignoring instruction will cause harm or damage. The seriousness is classified by the following indications.

⚠ WARNING This symbol indicates the possibility of death or serious injury.

⚠ CAUTION This symbol indicates the possibility of injury or damage to properties only.

- Meanings of symbols used in this manual are as shown below.

	Be sure not to do.
	Be sure to follow the instruction.

⚠ WARNING

■ When Installing

To install a product, inquire with a service center or a technician.

- Failure to do so may result in fire, electric shock, or injury.

To reinstall the product, please inquire with a service center or technician.

- Failure to do so may result in fire, electric shock, or injury.

Do not deliberately disassemble, repair, or modify the product.

- This may be a cause of fire or electric shock.

■ When Using

Do not place the product near fire.

- Doing so may start a fire.

Do not spill water on the product.

- Spilling water on this product may result in electric shock or damage to the product.

Do not cause an impact with the product or kick it with your foot.

- The impact to the product may cause a product defect.

Do not put a sharp and pointed object, etc. into a crack or gap.

- Doing so may result in electric shock or damage to the product.

Do not create an impact with a sharp and pointed object, etc.

- The damaged part may cause product damage.

Do not touch with a wet hand or pull a connecting cable.

- Product defect and electrical shock may result.



To install an air conditioner in a closed space, you must ensure ventilation measures.

- If the concentration becomes high due to a refrigerant leak, you may suffocate due to a lack of oxygen.

Do not use the product other than for its designated purpose.

- Product defects may result.

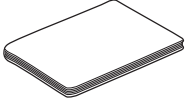
2. Components

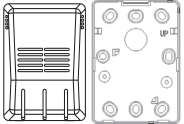
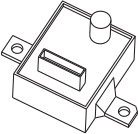
User/Installation Manual	6 Set Screws	Connecting Cable
 A line drawing of a rectangular, slightly rounded manual with a cover and pages.	 A line drawing of a single set screw with a hexagonal head and a threaded shaft.	 A line drawing of a coiled connecting cable with two different connector types at the ends.
Sensor Protective Cover	Sensor	
 Two line drawings of a sensor protective cover: one showing the front view with a central slot and ventilation, and the other showing the back view with various mounting holes and a label.	 A line drawing of a sensor component, which is a rectangular box with a central slot, a small cylindrical protrusion on top, and mounting tabs on the sides.	

3. Part Functions

Sensor

- LED: Displays the state of the sensor.
- Detecting Part : Detects the concentration of refrigerant R410A in the air.
- Connecting Cable Mating Section : Combines a cable connected to an indoor unit.

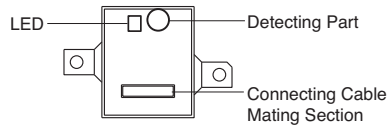

Connecting Cable

- Indoor Unit Connecting Part : Connects to the PCB of the indoor unit.
- Sensor Connecting Part : Connects to the sensor connecting cable mating section.

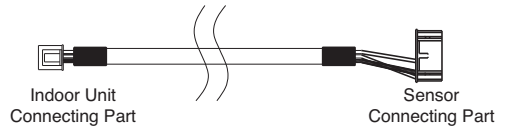

* Due to the different sizes of the connecting parts, the parts are not connected in reverse.

Sensor Protective Cover

- Connecting Cable Fixing Parts: Fix connecting cables to align wires.
- Sensor Fixing Parts: Guide to fix the sensor on the sensor protective case (backplate).
- LED Displaying Part: Possible to check the LED that displays the state of the internal sensor.

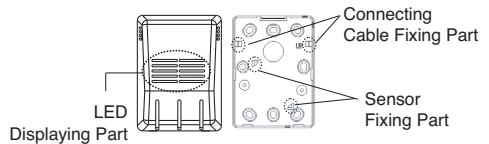

4. Part Specification

Sensor

Item	Unit	Spec.
Rated Voltage	V	DC 5.0 ± 5 %
Dimension (WxHxD)	mm	31 x 44 x 20
Weight	g	22
Refrigerant	-	R410A
Detected Concentration	ppm	0/6000, Alarm off/on
Operating Temperature Range	°C	-10 ~ 50
Preserved Temperature Range	°C	-40 ~ 60
Average Power Consumption	mA	35

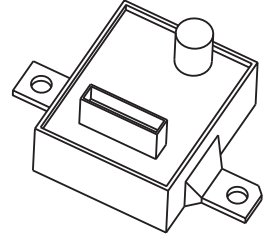

Connecting Cable

Item	Unit	Spec.
Type	-	Housing
Length	m	10

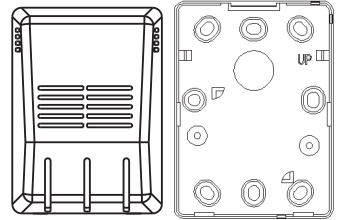

Sensor Protective Cover

Item	Unit	Spec.
Dimension of Front Plate (WxHxD)	mm	80x110x44.6
Dimension of Backplate (WxHxD)	mm	80x110x6.5

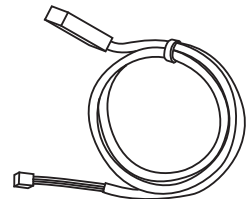

5. Refrigerant Leak Detector

Main Features

1. The refrigerant leak detector detects the concentration of refrigerant (R410A) in the air.
2. If the concentration of the refrigerant in the air exceeds 6000 ppm, the indoor unit buzzer, the error indicator on the wired remote control, and the sensor alarm go off to alert the user of a refrigerant leak.
3. To minimize a refrigerant leak, stop the operation of the indoor unit.
4. When the alarm of the refrigerant leak detector goes off, the user must ventilate until the alarm is disabled. (Indoor Unit Buzzer and Sensor LED)
5. Call the service center after ventilation.

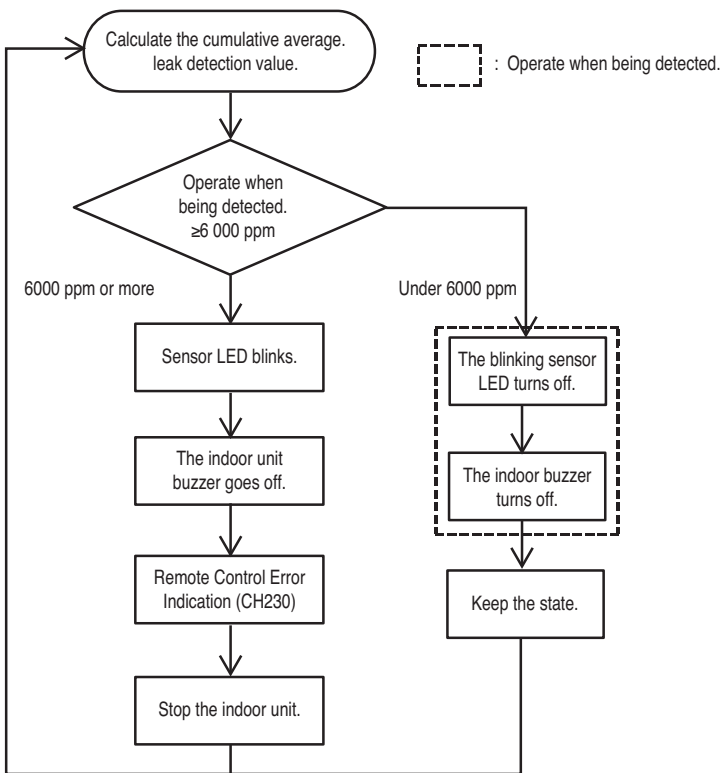

<Flowchart of Features of Leak Detector>

- When the concentration of the refrigerant becomes high, you may suffocate due to a lack of oxygen.
- Detect for only a refrigerant leak in the room where the product is installed.

Detector Alarm

1. Indoor Unit Alarm

- If the concentration of the refrigerant in the air exceeds 6000 ppm, the indoor unit buzzer goes off to alert the user.

* Release conditions: If the concentration of the refrigerant is 6000 ppm or less by ventilating the immediate vicinity, or the power button of the wired remote control, wireless remote control, and central control is pressed.

2. Wired Remote Control

- If the concentration of the refrigerant in the air exceeds 6000 ppm, the error code CH230 is displayed on the wired remote control.

* Disabling Conditions: Power to the indoor unit is cut off after 30 seconds.

3. Refrigerant Leak Detector

- Displays the state by using the LED of the indoor sensor of the refrigerant leak detector.
- If the concentration of the refrigerant in the air exceeds 6 000 ppm : The green and red LED lights blink at the same time.

* Release condition: When the concentration of the refrigerant is 6000 ppm or less by ventilating the immediate vicinity.

- Normal mode: The green LED always turns on.
- Out of order: The green and red LED lights blink in turn.

* If the product is out of order, contact the service center to change the sensor.

6. How to Install

1. Installation Place to Improve Detection Performance

- Installation Place by Refrigerant Characteristics

Because R410A is heavier than air, the refrigerant leak detector must be installed near the floor.

Install at a height of 300-500 mm off the ground (generally lower than the height of a bed).

- When installed at a height of less than 300 mm, it can make faulty detections.
- If installed at a height greater than 500 mm, the detection performance deteriorates.

2. Securing the Installation Location

- Install with the appropriate connecting cable length to connect from the indoor unit.
- It must be installed properly to help facilitate servicing.

- Do not install a connecting cable that is 50 m or longer.
(It may cause communication failure.)

3. Installation Place to Prevent Wrong Detection

- Other Gas Factors
 - Wrong alarm may go off due to gases other than R410A.
- Environmental Factors
 - It must be installed away from a cold wind or a heat source like a radiator.
 - Steam sources must be avoided.
 - A humid environment or water prone areas must be avoided.

- False detection concerning the location
 - * Places where other gases may be generated: Fruit storage, closed space, and places where exhaust gases are excessively emitted
 - * Places which are very humid or water prone: restroom, washstand

7. Installation Order

1. Affix the sensor protective case (backplate) firmly by using the set screws at a height of 300-500 mm from the floor.

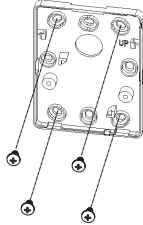

<How to Fix Screws>

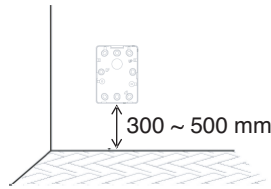

<Installation Place>

⚠ CAUTION

Do not install around the window or door. When it is installed, the refrigerant leak detector may fail to detect gases.

Do not install at a location where an electrical outlet is located. (Due to a gap with the sensor protective case (backplate), the cover may be bent.)

2. Keep the sensor affixed to the sensor protective case (backplate) firmly by using the provided set screws.

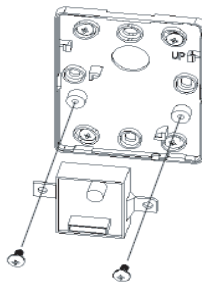

<How to Fix Sensor>

3. The connecting cable may be installed in four directions. Install by adjusting in the proper direction depending on the installation environment.
- Installation Direction: Wall embedded, upper, right, and bottom
 - When installing the connecting cable to the upper, right, or bottom surface, remove the guide grooves from the connecting cable. (*Remove the guide grooves with a long nose plier.)

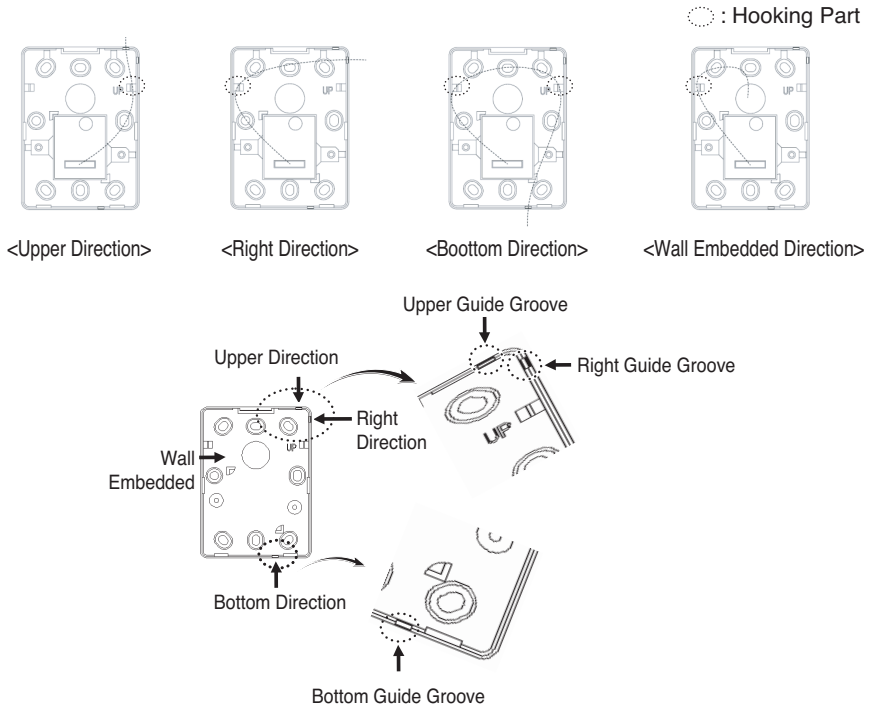

4. Connect the indoor unit and the sensor by using the connecting cable.

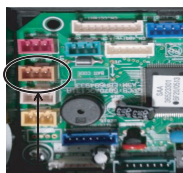
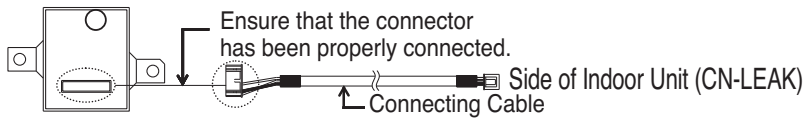

CN-LEAK

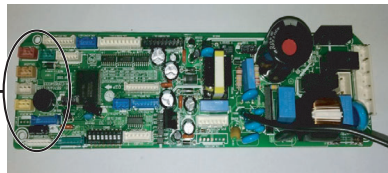

Indoor Unit PCB

5. Affix the upper part of the sensor protective cover (front plate) to the sensor protective case (backplate) that is attached to the wall as shown in the figure to the right. Press to combine with the bottom part.

- Assemble all four sides of the sensor protective cases to prevent any gap from occurring.

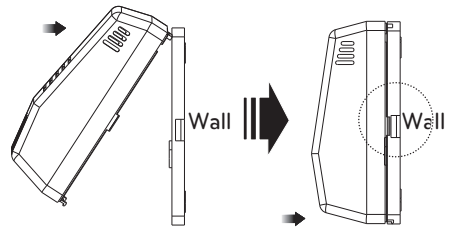

To remove the sensor protective cover, press the upper and bottom part of the sensor protective cover (front plate) as shown in the figure, and remove it away from the bottom part.

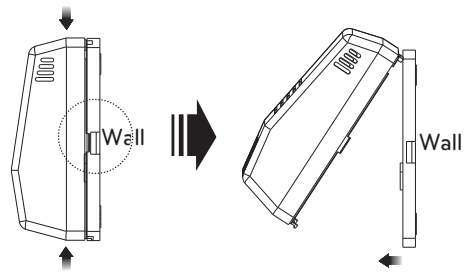

6. If the distance between the sensor and the indoor unit is 10 m or longer, use an extension cable.

- Do not install a cable that is 50 m or longer. (It may cause communication failure.)

* To purchase extension cables, contact a specialized company (Hisys).

CAUTION

When installing the refrigerant leak detector, do not embed into the wall.

Do not install a cable that is 50 m or longer. (It may cause communication failure.)

* To install the extension cable, check the direction of the refrigerant leak detector connected to the indoor unit.

* When the extension cable is connected in reverse, the connector cannot be connected.

* Extension cable specification: Use 2547 1007 22# 2core 3shield, 5Ø or equivalent or higher level.

8. Test Run

Pre-check

This is a step to check whether the refrigerant leak detector is properly installed for the test run.

1. Check whether the power is connected.
2. After connecting the power, 7 seconds is the initial sensor startup time.
3. After 7 seconds, ensure that the green LED light turns on.

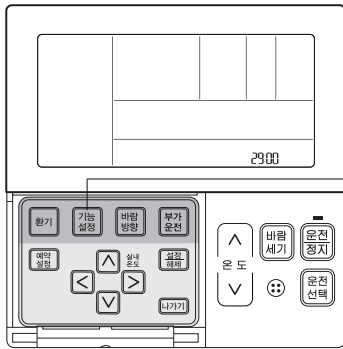

Checking the refrigerant leak detector setting - Wired Remote Control

A function to set when a refrigerant leak detector is newly installed for an indoor unit, or the existing installation is removed.

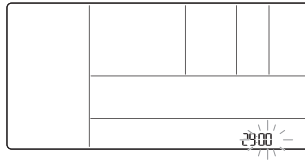

1. Press the function setting button for three seconds or more to move to the remote control installer setting mode.
 - Press once shortly to move into the user setting mode. It must be pressed for at least 3 seconds.
2. Press the function setting button repeatedly to move to the menu for checking the setting of the refrigerant leak detector as shown in the figure to the right.



3. Select functional code value 29 and setting value 01 by using the   button.

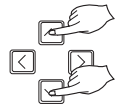

CAUTION

When non-installation is set, if the refrigerant leaks, the alarm of indoor unit buzzer and remote control does not go off.

4. When the function selection ends, press the Set/Release button to complete the setting.
 5. Press the Go Out button to move out from the setting mode.
- * If there is no button entry roughly for 25 seconds after setting, automatically move out to the setting mode.
 - * If it is closed without pressing the Set button, the operational value is not set.

Checking the refrigerant leak detector setting - Wireless Remote Control

CAUTION

The installer setting mode is a mode for setting the detailed features of the indoor unit. If the installer setting mode is set incorrectly, a product defect, user injury, or property damage may occur. It must be set only by qualified installation technicians who hold an installation license. Any and all problems arising from the installation or arbitrary changes without having such a license are the responsibility of the installer. In this instance, we do not conduct services free of charge.



1. Press the RESET button once while pressing the Wind Intensity button and then the display window appears as shown in the left figure.

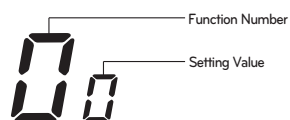

2. Set the address with the temperature control button.
 - Press the temperature up button one at a time to reach the desired temperature. (Select the function number.)
 - Press the temperature down button one at a time. (Designate the setting value.)



3. Designate the function number and the setting value and then press the Start/Stop button to complete the setting.
E.g., If you press the temperature increase button two (2) times and then press the temperature decrease button two (2) times, the message shown on the right will appear

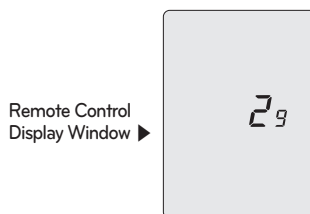

4. When the setting ends, press the RESET button to exit the installer setting mode.

Leak Check for Refrigerant Leak Detector

1. Have gas enter through the opening of the sensor protective case by using the gas from a gas lighter.
(Proceed when the sensor protective case has been assembled.)
 - Until the sensor detects the gas lighter, continue to open the valve of the gas lighter.

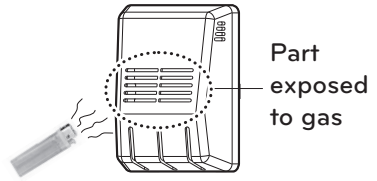

CAUTION

Do not expose the gas lighter to the sensor part for an extended period of time. (If the gas concentration level becomes very high, the sensor may go out of order). Use the gas lighter when the sensor protective cover is assembled. (When it is exposed directly, the sensor may go out of order.)

2. When the leak is detected, an alarm is displayed on the leak detector, indoor unit, and wired remote control.

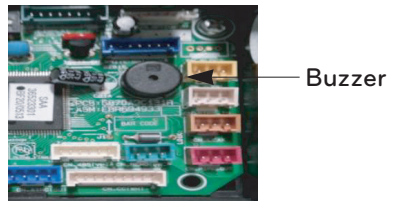
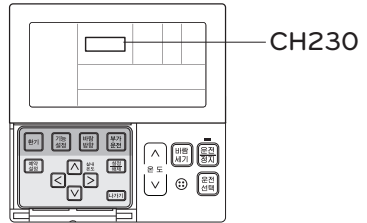
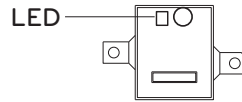

- * Refrigerant leak detector: The green and red LED lights blink simultaneously.
(Check through the opening of the sensor protective case.)
- * Indoor unit: Buzzer alarm
- * Wired remote control: CH230 displayed

When a leak is not detected or the sensor is out of order, the following alerts appear:

- * When a leak is not detected: The green LED always turns on.
- * Out of order: The green and red LED lights blink out of turn.

3. After ventilating the surrounding area, shut down the power of the indoor unit where the leak is detected and then turn it on again.
(Roughly 30 seconds after shutdown, turn the power on.)

- Ventilate until the green LED of the sensor stays constantly on.

9. Checkup before Reporting Trouble

If there is any problem with the product, check the following before inquiring with the service center:

Symptom	Checkup	Action
The power is not supplied. (The light of the refrigerant leak detector does not turn on.)	• Is the air conditioner powered on?	• Check the circuit breaker. • Check the state of the installation of the refrigerant leak detector.
	• Is the connecting cable between the air conditioner and the refrigerant leak detector properly connected?	• Connect the cable between the air conditioner and the refrigerant leak detector.
	• Are the cables properly connected?	• Check again by referring to how to install in the manual.
Error "CH230" is displayed on the remote control display window and the indoor unit does not run.	• Are the connecting cables properly connected?	• Check again by referring to the order of the installation in the manual.
	• Do the green and red LED lights of the detector blink alternately?	• The internal sensor of the refrigerant leak detector is out of order. • Contact the service center for replacement.
	• Do the green and red LED lights of the detector blink simultaneously?	• Refrigerant leak is detected. • Rapidly ventilate and then contact the service center.
The buzzer alarm turns on in the indoor unit and is not operable.	• Are the connecting cables properly connected?	• Check again by referring to the order of the installation in the manual.
	• Do the green and red LED lights of the detector blink alternately?	• The internal sensor of the refrigerant leak detector is out of order. • Contact the service center for replacement.
	• Do the green and red LED lights of the detector blink simultaneously?	• Refrigerant leak is detected. • Rapidly ventilate, then contact the service center.
The light of the refrigerant leak detector blinks.	• Do the green and red LED lights of the detector blink alternately?	• The internal sensor of the refrigerant leak detector is out of order. • Contact the service center for replacement.
	• Do the green and red LED lights of the detector blink simultaneously?	• Refrigerant leak is detected. • Rapidly ventilate, then contact the service center.

Error Number	Error Description	Meaning	Main Cause
230	Error with detecting refrigerant leak	Refrigerant leak detection and sensor failure error	<ol style="list-style-type: none"> 1. Incorrect setting for the refrigerant leak detector 2. Short failure of the refrigerant leak detector terminal 3. Wrong connection of the refrigerant leak detector 4. Failure with the refrigerant leak detector 5. Refrigerant leak detection

■ Troubleshooting

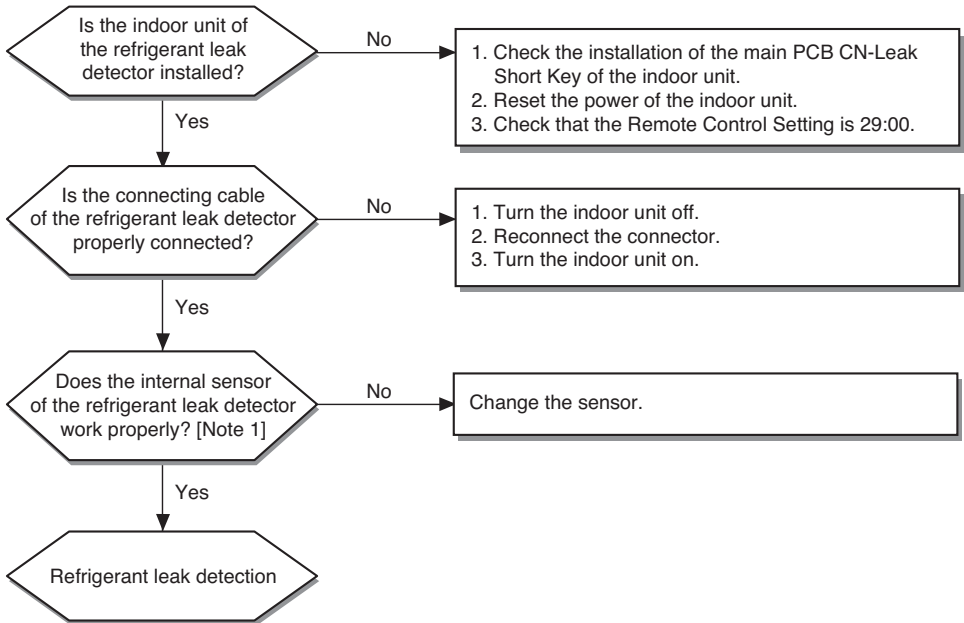

[Note 1] Check the normal state of the refrigerant leak detector.

- Normal state: The green LED light turns on or the green and red LED lights blink at the same time.
- Failure state: The green and red lights blink alternately.

